



OUTDOOR DINING SERVING SOLUTIONS



Providing Solutions for over 75 Years
Every Ware. Every Day.

PULITO COLLECTION™

Elevate your tabletop setting with our exclusively designed Pulito Collection™. Designed to resemble beautiful hand thrown ceramic pieces and constructed of dishwasher safe melamine.

- Natural white “porcelain” color is neutral to match any décor
- Salt & Pepper Shakers feature rubber stoppers on the bottom for easy cleaning and refilling, sold as a set of 2
- Creamer, sugar packet holder and sugar jar with lid are beautiful additions to keep your tabletop clean and organized
- Sugar Jar with lid is also perfect for holding sugar tubes
- Wide Rim Bowl is an upscale and durable serving option for your pasta entrees, soups, salads and more!
- Durable melamine construction
- Safe for temperatures up to 212°F
- Easy to clean, dishwasher safe

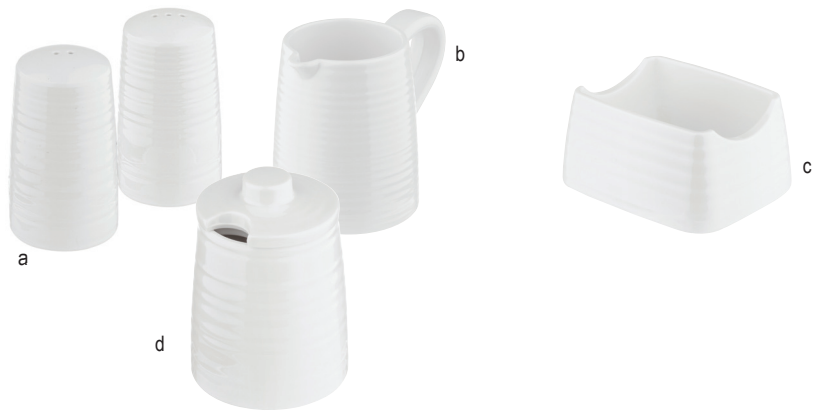

AL FRESCO with DURABLE SERVEWARE



Item #	Description	Capacity	Min Order
PULITO COLLECTION™ ADDITIONS—MELAMINE, WHITE, TEXTURED FINISH			
e.	10515 Side Plate, 6" dia x 5/8"	–	1 ea
f.	10496 Round Platter, 13 1/8" dia x 1"	–	1 ea
g.	11146 Oval Platter, 15 x 11 1/4 x 7/8"	–	1 ea
h.	123460 Wide Rim Bowl, 10" dia x 2 3/8"	14 oz	1 ea
i.	11147 Wide Rim Bowl, 12" dia x 2 3/8"	28 oz	1 ea
j.	11514 Round Plate, 9 dia x 1"	–	1 ea
k.	11148 Round Plate, 10 1/2" dia x 7/8"	–	1 ea
l.	11149 Round Coupe Bowl, 8 1/2" dia x 2 3/8"	24 oz	1 ea
m.	11150 Round Coupe Bowl, 9 1/4" dia x 3"	48 oz	1 ea

The beautiful "hand thrown" details and subtle color will have you convinced this is *actually* porcelain



please pass
the **pulito**

Side Plate is ideal for small plate service, appetizers, or use as a saucer for creamer or cup



mediterranean meets melamine



MELAMINE OLIVE WOOD SERVING PADDLES

Our Melamine Olive Wood Decal Serving Paddles are perfect for serving indoors and outdoors due to their durability. Their olive wood decal gives a more casual but rustic look.

- Olive wood decal
- Durable, lightweight melamine
- Easy to clean, dishwasher safe



Textured pattern resembles upscale olive wood that can be dressed up or down



View a video on the benefits of our Melamine Olive Wood Serving Paddles!

Item #	Description	Min Order	List Price (\$)
SERVING BOARDS-MELAMINE, OLIVE WOOD DECAL, BLACK			
a. 11182	Rectangular Paddle, 12 x 7" (4½" Handle)	1 ea	21.00 ea
11183	Round Paddle, 10" dia x ¾" (3¾" Handle)	1 ea	20.00 ea
b. 11184	Round Paddle, 12" dia x ¾" (3¾" Handle)	1 ea	26.00 ea

BARNWOOD COLLECTION™

Create a memorable dining experience with our melamine buffet and serving collection with exclusive "barnwood" pattern.

- Ideal for rustic buffets, farm-to-table restaurants or pool side meals
- Durable, lightweight melamine
- Available in a variety of shapes & sizes



Item	Description	Min Order/ Case Pack
PADDLES, TRAYS & PLATTERS - MELAMINE		
a. 10016	Round Paddle 12½" dia, 16½" w/ Handle	1 ea / 6 ea
b. 10017	Rectangular Paddle 8 x 10", 12" w/Handle	1 ea / 6 ea
c. 10019	Rectangular Tray 11 x 5¾"	1 ea / 6 ea
d. 10021	Square Platter 10 x 9¾"	1 ea / 6 ea
e. 10022	Square Platter 11¾ x 11½"	1 ea / 6 ea
f. 10023	Square Platter 15 x 14½"	1 ea / 4 ea



faux cast iron

Now available
in white



View a video on
the benefits of
our Faux Cast
Iron Melamine
Serving Trays!



Vitamin M
for Living
designed by Monier M.



b / d / f

FAUX CAST IRON MELAMINE SERVING TRAYS

Our Melamine Serving Trays with faux cast iron finish are perfect for serving and displaying entrées, sides, beverages, desserts and more!

- Matte finish with texture to resemble cast iron
- Coordinates with our existing melamine serving skillets with cast iron texture
- Durable, lightweight melamine



Item #	Description	Min Order
FAUX CAST IRON SERVING TRAYS—MELAMINE		
a.	10047 Black, 10¾ x 8 x ¾" (¾" Handles)	1 ea
b.	11494 White, 10¾ x 8 x ¾" (¾" Handles)	1 ea
c.	10331 Black, 12 x 10 x ¾" (1" Handles)	1 ea
d.	11493 White, 12 x 10 x ¾" (1" Handles)	1 ea
e.	10048 Black, 17¾ x 13¼ x ¾" (1¼" Handles)	1 ea
f.	11495 White, 17¾ x 13¼ x ¾" (1¼" Handles)	1 ea



h



g

FAUX CAST IRON MELAMINE SERVING SKILLETS

- Enhance your entrées, sides and desserts with our collection of melamine skillets and servers
- Melamine provides a unique serving presentation
- Durable, lightweight and easy to clean, dishwasher safe
- Not microwave or oven safe



Item #	Description	Capacity	Min Order
ROUND SERVING SKILLETS—MELAMINE			
MSKLT65	6½ dia x 1¾" (3" Handle)	10 oz	1 ea
g. MSKLT85	8½ dia x 2¼" (4¾" Handle)	26 oz	1 ea
SQUARE SERVING SKILLETS—MELAMINE			
MSSKLT5	5 x 5 x 1¾" (¾" Handles)	9 oz	1 ea
h. MSSKLT65	6½ x 6½ x 1¾" (1" Handles)	16 oz	1 ea
i. MSSKLT85	8½ x 8½ x 1¾" (1" Handles)	32 oz	1 ea

Faux Cast Iron Skillet and Ramekins on our Lindenwood Collection™ melamine serving platter featured on page 160.



i

FROSTONE SLATE COLLECTION™

Bring elegance to your display with the high-end look of natural materials in lightweight, durable melamine. Mix and match a variety of shapes and sizes to create the perfect display. Safe for low temperature display, but not microwave or oven safe. Easy to clean, dishwasher safe.



a

Item #	Description	Min Order
RECTANGULAR DISPLAY TRAY—MELAMINE		
a. MG1	Black Slate, 20¾ x 12¾"	1 ea
b. MG1WM	White Marble, 20¾ x 12¾"	1 ea
MG2	Black Slate, 12¾ x 10¾"	1 ea
MG3	Black Slate, 12¾ x 6¾"	1 ea
MGL2	Black Slate, 20¾ x 6¾"	1 ea
ROUND DISPLAY TRAY—MELAMINE		
MG13	Black Slate, 13" dia	1 ea
c. MGC13	Black Slate with Channel, 13" dia	1 ea
MG16	Black Slate, 16" dia	1 ea



b

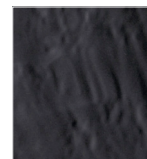

Black Slate



White Marble

Sized to fit perfectly on a variety of our **Gastronorm Display Crates**



c

Includes channel for use with domes

FROSTONE COLLECTION™ SERVING PADDLES & DISPLAYS

Serve appetizers, sandwich platters or charcuterie with industrial charm using our handled faux slate paddles.



Item #	Description	Min Order
RECTANGULAR SERVING PADDLES—MELAMINE		
d. MSP3618	Black Small, 9¾ x 7"-4½" Handle	1 ea
11496	White Small, 9¾ x 7"-4½" Handle	1 ea
MSP4520	Black Medium, 13 x 8¾"-4¾" Handle	1 ea
e. 11497	White Medium, 13 x 8¾"-4¾" Handle	1 ea
MSP5120	Black Large, 15¾ x 7¾"-5" Handle	1 ea
11498	White Large, 15¾ x 7¾"-5" Handle	1 ea
DISPLAY TRAYS—MELAMINE, BLACK SLATE		
f. MGD2112	Rectangular, 21 x 12½ x 1½"	1 ea
g. MGD1616	Square, 16¾ x 16¾ x 1½"	1 ea

Offset handle makes serving and table placement easier

Raised lip keeps food from sliding off edge



d

Ideal for cabana snacks and service



f/g

Raised to bring height and interest to your buffet display. Plus, beautifully incorporated curved cut-outs allow for easy access to lift and transport comfortably.

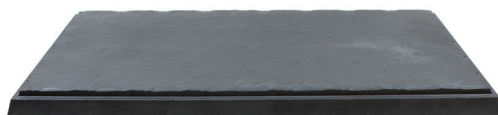

DISPLAYS



e

Now available in white!

SIERRA MELAMINE COLLECTION™ SERVING PLATTERS

Enhance your buffet line with these new melamine round and oval platters that coordinate with our existing Sierra Collection™ bowls to complete your buffet-scape.

- Durable, break-resistant design for extended use
- Not microwave or oven safe
- Easy to clean, dishwasher safe



Item	Description	Min Order
SERVING PLATTERS—MELAMINE, WHITE		
a.	11526 Oval, 14¼ x 11¼ x 1"	1 ea
b.	11527 Oval, 16¼ x 12¾ x 1"	1 ea
c.	11528 Oval, 18 x 13¾ x 1"	1 ea
d.	11529 Oval, 20 x 15¼ x 1"	1 ea
e.	11530 Round, 12½ dia x 1¼"	1 ea
f.	11531 Round, 13" dia x 1¼"	1 ea
g.	11532 Round, 14" dia x 1¼"	1 ea
h.	11533 Round, 15¼" dia x 1¼"	1 ea





Just the right size.

New Straight Sided Ramekins and Bowls in white come in a range of sizes, to provide versatility for your service. Ideal for serving side dishes, dips, sauces, dressings or desserts. Nests together for easy storage!

- Natural white “porcelain” color is neutral to match any décor
- Durable melamine construction
- Safe for temperatures up to 212°F
- Easy to clean, dishwasher safe



Item	Description	Capacity	Min Order
ROUND STRAIGHT SIDED RAMEKINS AND BOWLS- MELAMINE, WHITE			
a.	11407 2% dia x 1½" Ramekin	2 oz	1 ea
b.	11408 3 dia x 1¾" Ramekin	3 oz	1 ea
c.	11409 3¼ dia x 1⅝" Ramekin	4 oz	1 ea
d.	11410 3¾ dia x 2⅝" Ramekin	6 oz	1 ea
e.	11411 4% dia x 2½" Bowl	10 oz	1 ea
f.	11412 4% dia x 2¾" Bowl	12 oz	1 ea
g.	11413 4% dia x 2⅞" Bowl	14 oz	1 ea



uniquely crafted

servicing collections

EUROPA COLLECTION™ SERVING PLATTERS, BOWLS & PLATES

Get the look of artisanal stoneware with the durability of melamine with our Europa Collection™. This line features a neutral, deglazed white ceramic style. Bowls and plates feature an irregular rim shape to more perfectly resemble authentic ceramic serving pieces.

- Perfect for indoor and outdoor serving
- Unique matte finish with beige rim and textured pattern resembles upscale ceramic pieces
- Platters are great for serving entrees or larger portions for buffet and catering
- Platters available in 10¾", 14", 16" and 18" diameters
- Melamine—easy to clean, dishwasher safe



Item #	Description	Min Order
EUROPA COLLECTION™ –MELAMINE, WHITE STONE PATTERN WITH BEIGE RIM		
ROUND PLATTER		
a.	123515W 10¾" dia x 7/8"	1 ea
b.	123517W 14" dia x 7/8"	1 ea
c.	123518W 16" dia x 7/8"	1 ea
d.	123519W 18" dia x 7/8"	1 ea
BOWL		
e.	10965 13 oz, 6¾ x 5 x 3¼"	1 ea
f.	10966 30 oz, 9 x 6 x 3¾"	1 ea
PLATE		
g.	11515 7 x 6 x 7/8"	1 ea
h.	11516 9 x 7¾ x 1"	1 ea
i.	10967 10½ x 9 x 1½"	1 ea
j.	10968 13¼ x 11½ x 1¼"	1 ea

LUNARA COLLECTION™

BOWL & PLATE ADDITIONS

Enhance the look of your serving presentation with our extended Lunara Collection™! Including bowls and plates to complete the hand thrown stoneware look. New pieces feature an irregular rim shape to perfectly resemble authentic ceramic serving pieces, but with the durability of melamine; perfect for indoor and outdoor serving.

- Unique matte finish with copper flecks and textured pattern resembles upscale ceramic pieces
- Smallest bowl (10888) features a 3½ oz capacity, perfect for sauce and dressing serving
- Safe for holding food up to 212° Fahrenheit
- Lightweight and durable



Textured pattern resembles upscale ceramic pieces that can be dressed up or down; these pieces are great for casual dining or upscale tabletop settings.



Textured pattern resembles upscale ceramic pieces that can be dressed up or down; these pieces are great for casual dining or upscale tabletop settings.

Item #	Description	Min Order
LUNARA COLLECTION™ –MELAMINE, BROWN WITH COPPER FLECKS		
ROUND PLATTER		
a.	123515BR 10¾" dia x ¾"	1 ea
b.	123517BR 14" dia x ¾"	1 ea
c.	123518BR 16" dia x ¾"	1 ea
d.	123519BR 18" dia x ¾"	1 ea
BOWL		
e.	10888 3½ oz, 4 x 2¾ x 2¾"	1 ea
f.	10889 13 oz, 6¾ x 5 x 3¾"	1 ea
g.	10890 30 oz, 9 x 6 x 3¾"	1 ea
PLATE		
h.	11517 7 x 6 x ¾"	1 ea
i.	11518 9 x 7¾ x 1"	1 ea
j.	10891 10½ x 9 x 1½"	1 ea
k.	10892 13¼ x 11½ x 1¼"	1 ea

TERRA COLLECTION™ SERVING PLATES & BOWLS

Our Terra Collection will easily refresh your tablescapes while offering a durable but stylish solution for serving appetizers, entrees, and desserts.

- Matte finish available in white or gray with speckles
- Safe for temperatures up to 212°F
- Easy to clean, dishwasher safe



Item #	Description	Min Order
TERRA COLLECTION™-MELAMINE, WHITE		
SERVING PLATE		
a.	11803 7½" dia x ¾"	1 ea
b.	11804 9" dia x ¾"	1 ea
c.	11805 11" dia x ¾"	1 ea
SERVING BOWL		
d.	11806 24 oz, 9" dia x 2"	1 ea
e.	11807 48 oz, 11" dia x 2¼"	1 ea
TERRA COLLECTION™-MELAMINE, GRAY WITH SPECKLES		
SERVING PLATE		
f.	11808 7½" dia x ¾"	1 ea
g.	11809 9" dia x ¾"	1 ea
h.	11810 11" dia x ¾"	1 ea
SERVING BOWL		
i.	11811 24 oz, 9" dia x 2"	1 ea
j.	11812 48 oz, 11" dia x 2¼"	1 ea





MELAMINE SHEET PANS

Sheet Pans designed to have the look of enamelware but with the durability of melamine. The white color with black rims bring timeless style to your table. Great for serving appetizers, entrees, and desserts.

- Unique matte finish on outside with glossy finish inside
- Safe for temperatures up to 212°F
- Easy to clean, dishwasher safe



Item	Description	Min Order
	SHEET PANS—MELAMINE, WHITE DECALED WITH BLACK RIM	
11669	Fourth Size 13 x 9½ x 1½"	1 ea
11671	Eighth Size, 10⅝ x 6 x 1½"	1 ea

Shatterproof and scratch-resistant melamine offers worry-free dining experiences both indoors and outdoors. It is a durable and convenient option for those looking for a practical and stylish alternative to traditional enamelware.



Elegant styling



RIDGE COLLECTION™ SERVING PLATES & BOWLS

Whether its for a special occasion or enhancing your tabletop, these Ridge Collection plates and bowls resemble ceramic serving pieces with a high gloss textured finish. However, they offer the durability of melamine while still providing elegance to your tabletop.

- Melamine—easy to clean, dishwasher safe
- Heat safe up to 212°F



Item #	Description	Min Order
RIDGE COLLECTION™—MELAMINE, WHITE, HIGH GLOSS FINISH		
SERVING PLATE		
a.	11862 7½" dia x ¾"	1 ea
b.	11863 9" dia x ¾"	1 ea
c.	11864 11" dia x ¾"	1 ea
SERVING BOWL		
d.	11865 24 oz, 9" dia x 2"	1 ea
e.	11866 48 oz, 11" dia x 2¼"	1 ea

See our Ridge Collection™
Serving Platters on page 68-69
in our catalog

LATTICE COLLECTION™

- Create a casual dining experience with our Lattice Collection™ Stainless Steel construction with an embossed basketweave pattern
- Available in a variety of styles and sizes; these pieces add a casual feel to your shareable sides and entrees



Item #	Description	Capacity	Min Order
LATTICE COLLECTION™-STAINLESS STEEL WITH EMBOSSED BASKETWEAVE PATTERN			
PLATTERS			
a.	10034 Round, 8 $\frac{1}{8}$ " dia x 1 $\frac{1}{2}$ "	-	1 ea
b.	10035 Round, 10 $\frac{1}{2}$ " dia x 1 $\frac{1}{4}$ "	-	1 ea
c.	10036 Oval, 9 $\frac{1}{2}$ x 6 $\frac{1}{4}$ x 2 $\frac{1}{8}$ "	-	1 ea
d.	10037 Oval, 12 x 9 x 2 $\frac{1}{8}$ "	-	1 ea
e.	10038 Rectangular, 9 $\frac{3}{4}$ x 7 x 1 $\frac{1}{8}$ "	-	1 ea
f.	10039 Rectangular, 12 x 9 x 1 $\frac{1}{4}$ "	-	1 ea
PAIL			
g.	10041 Round, 4" dia x 4"	16 $\frac{1}{2}$ oz	1 ea
h.	11186 Round, 8 $\frac{1}{8}$ " dia x 7"	1 $\frac{1}{4}$ gal	1 ea
FRY CUPS			
i.	10042 Slanted Round, 3 $\frac{3}{4}$ " dia x 4 $\frac{3}{4}$ "	10 oz	1 ea
j.	10043 Tapered Square, 4 x 4 x 3 $\frac{1}{2}$ "	20 oz	1 ea
CADDY, SNACK SET & TRAY			
k.	10040 Rectangular Caddy, 10 $\frac{3}{4}$ x 8 $\frac{3}{4}$ x 4 $\frac{3}{4}$ "	-	1 ea
l.	10486 Four Piece Snack Set, Includes Tray (10488) & (3) Cups (10487)	(3) 23 oz	1 ea
m.	10487 Round Cup, 4 $\frac{1}{8}$ " dia x 4 $\frac{1}{8}$ "	23 oz	1 ea
n.	10488 Snack Tray, 14 $\frac{1}{2}$ x 4 $\frac{1}{4}$ "		1 ea
MUGS			
o.	11657 3" dia x 3 $\frac{3}{4}$ "	14 oz	1 ea
p.	11658 3 $\frac{3}{4}$ " dia x 4"	23 oz	1 ea

These mugs are the newest addition to our collection. Perfect for serving sides or keeping your drink cool!



Caddy with all Stainless Steel handle is dishwasher safe

BRICKHOUSE COLLECTION™

- Perfect for indoor and outdoor dining; fast-casual serving solutions
- Available in a variety of styles and sizes; for serving shareable sides, entrees or beverage options



Item #	Description	Capacity	Min Order
BRICKHOUSE COLLECTION™—STAINLESS STEEL WITH EMBOSSED BRICK PATTERN			
PLATTERS			
a.	GPSS8 Round, 8 $\frac{1}{8}$ " dia x 1 $\frac{5}{8}$ "	—	1 ea
	GPSS10 Round, 10 $\frac{1}{2}$ " dia x 1 $\frac{5}{8}$ "	—	1 ea
b.	GPSS96 Oval, 9 $\frac{1}{2}$ x 6 x 2 $\frac{1}{8}$ "	—	1 ea
c.	GPSS129 Oval, 12 $\frac{1}{4}$ x 8 $\frac{3}{4}$ x 2 $\frac{1}{4}$ "	—	1 ea
d.	GPSS90 Rectangular, 9 $\frac{3}{4}$ x 6 $\frac{1}{2}$ x 1 $\frac{3}{4}$ "	—	1 ea
	GPSS120 Rectangular, 12 x 9 x 1 $\frac{3}{4}$ "	—	1 ea
PAILS			
e.	GTSS33 Round, 3 $\frac{5}{8}$ " dia x 3 $\frac{1}{4}$ "	9 oz	1 ea
f.	GTSS44 Round, 4 $\frac{1}{8}$ " dia x 3 $\frac{3}{4}$ "	16 $\frac{1}{2}$ oz	1 ea
g.	GTSS87 Round, 8 $\frac{1}{8}$ " dia x 7"	1 $\frac{1}{4}$ gal	1 ea
CADDY			
h.	GPSSCADDY Rectangular, 10 $\frac{3}{4}$ x 8 $\frac{1}{4}$ x 4 $\frac{3}{4}$ "	—	1 ea
FRY CUPS			
i.	GTSS28 Slanted Round, 3 $\frac{3}{8}$ " dia x 4 $\frac{3}{4}$ "	9 $\frac{1}{2}$ oz	1 ea
	GTSS375 Slanted Round, 3 $\frac{3}{4}$ " dia x 4 $\frac{3}{4}$ "	10 oz	1 ea
j.	GTSS31 Round, 3 $\frac{1}{2}$ " dia x 3 $\frac{1}{2}$ "	13 oz	1 ea
k.	GTSS4 Tapered Square, 3 $\frac{3}{8}$ x 3 $\frac{3}{8}$ x 3 $\frac{5}{8}$ "	20 oz	1 ea
	GTSS45 Round, 4" dia x 4 $\frac{1}{2}$ "	23 oz	1 ea
RAMEKINS			
l.	GRSS1 Round, 2 $\frac{3}{8}$ " dia x 1"	1 $\frac{1}{2}$ oz	12 ea
m.	GRSS2 Round, 2 $\frac{1}{4}$ " dia x 1 $\frac{3}{4}$ "	2 $\frac{1}{2}$ oz	12 ea
n.	GRSS3 Round, 2 $\frac{3}{4}$ " dia x 1 $\frac{3}{4}$ "	3 oz	12 ea
MUGS			
o.	11659 3 $\frac{1}{4}$ " dia x 3 $\frac{1}{2}$ "	16 oz	1 ea
p.	11660 3 $\frac{3}{4}$ " dia x 4"	24 oz	1 ea



Caddy is hand wash only because of wood handle

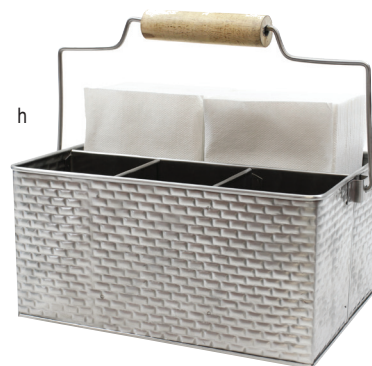



What makes more than just burgers better?

BETTER BURGER COLLECTION™

Our Better Burger Collection™ adds flair and fun to your upscale fast food service. Perfect for pubs, grills and fast-casual presentations! This unique collection reimagines traditional "fast food" serving pieces in elegant Stainless Steel or durable, lightweight melamine.

- Perfect for gastro pubs, industrial decor or fast casual burger & BBQ
- 18/8 Stainless Steel or durable, lightweight melamine construction

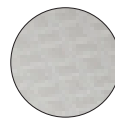
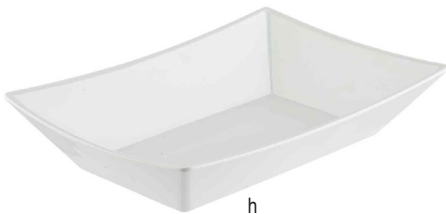
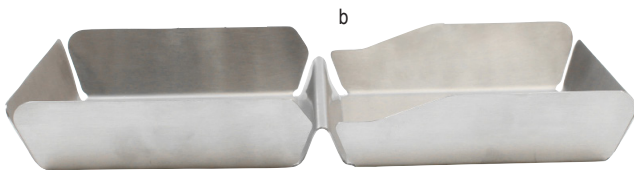

Serving trays feature an engraved nostalgic weave pattern

Item #	Description	Min Order
Stainless Steel Options		
FRY BOXES—STAINLESS STEEL		
a. 20006	Brushed S/S, 4¼ x 1¼ x 4½"	1 ea
BURGER BOXES—STAINLESS STEEL		
b. 20003	Brushed S/S, 11¾ x 6¼ x 1½"	1 ea
FRY TRAYS—STAINLESS STEEL		
20008	Small, Brushed S/S Tray, 5½ x 3½ x 1¼"	1 ea
c. 20009	Medium, Brushed S/S Tray, 7½ x 5 x 1⅞"	1 ea
d. 123524	Large, Brushed S/S Tray, 8½ x 5¾ x 2"	1 ea
123525	Extra Large, Brushed S/S Tray, 9¼ x 6½ x 2"	1 ea
SERVING TRAYS—STAINLESS STEEL, WEAVE PATTERN		
e. 20005	Small, Brushed S/S, Weave Pattern, 10 x 7 x ½"	1 ea
f. 20004	Large, Brushed S/S, Weave Pattern, 14 x 10 x ½"	1 ea
FRY TRAYS—MELAMINE		
20028W	Small, Tray, 5 x 3¾ x 1¼", White	1 ea
20028BK	Small, Tray, 5 x 3¾ x 1¼", Black	1 ea
g. 20029W	Medium, Tray, 7¾ x 4¾ x 1⅞", White	1 ea
20029BK	Medium, Tray, 7¾ x 4¾ x 1⅞", Black	1 ea
h. 12350002	Large, Tray, 8½ x 5¾ x 1⅞", White	1 ea
12350102	Extra Large, Tray, 9¼ x 6½ x 1⅞", White	1 ea
SPATULA SERVER—STAINLESS STEEL, MELAMINE HANDLE		
i. 20001	S/S with Faux Wood Handle, 16 x 3½ x 2⅝"	1 ea
SPATULA SERVER FLIGHT—STAINLESS STEEL, MELAMINE HANDLE		
j. 20002	S/S with Faux Wood Handle, 16 x 3½ x 3¼"	1 ea
RAMEKINS—MELAMINE, WHITE		
n. 240003	2 oz, 2⅞" dia x 1⅞"	12 ea
o. 240004	3 oz, 2⅞" dia x 1⅞"	12 ea
p. 240005	6 oz, 3⅞" dia x 2⅞"	12 ea
SAUCE CUPS—MELAMINE, WHITE		
q. 240008	2 oz, 2⅞ x 2⅞ x 1¼"	12 ea
r. 240009	3 oz, 3 x 2½ x 1⅞"	12 ea



Dessert sampler to show or serve



Tasting flights

Holds 2¼" dia glasses FLBEER4 (glasses not included); see page 231



n / p

Souffle cups look like the traditional paper cups updated in durable melamine. A fun way to present dipping sauces and sides.



q / r



SIDE SERVERS

Stainless Steel Side Servers are perfect for portioned control sides. These side servers create a casual dining experience and are perfect for serving your sides such as potatoes, vegetables, and mac and cheese.

- Great for indoor or outdoor service
- Stainless Steel construction
- Easy to clean, dishwasher safe



a - c

WIRE SIDE SERVING BASKETS IN STAINLESS STEEL

Serving baskets with mesh metal wire for convenient and perfectly portioned sides. The larger rectangular serving basket with handle is great for serving entrees and sides, burgers, sandwiches and more!

- 18/8 Stainless Steel Mesh Wire
- For use with paper or fabric liners
- Easy to clean, dishwasher safe



HOT HOLDING
UP TO 500°F



h



e



i

j

Item #	Description	Min Order
SIDE SERVERS-STAINLESS STEEL		
a. 11435	Server, 3¼" dia x 1¼" (3½" Handle)	1 ea
b. 11436	Server, 3½" dia x 1⅝" (4" Handle)	1 ea
c. 11437	Server, 3¾" dia. x 3" (4" Handle)	1 ea
SERVING BASKETS-STAINLESS STEEL		
d. 10521	Rectangular Basket, 9¼ x 6¾ x 1⅝"	1 ea
e. 10522	Square Basket, 9¾ x 9¾ x 1⅝"	1 ea
f. 10523	Rectangular Basket, 14¼ x 6¾ x 1⅝"	1 ea
g. 10524	Rectangular Basket, 12 x 8 x 1⅝"	1 ea
SERVING BASKETS-STAINLESS STEEL		
h. 10970	Square Wire Serving Basket, 4 x 4 x 3¼"	1 ea
i. 10971	Rectangular Wire Serving Basket, 6 x 4 x 3¼"	1 ea
j. 10972	Rectangular Wire Serving Basket, 9 x 7 x 3¼"	1 ea

WIRE SERVING BASKETS IN STAINLESS STEEL

Stainless Steel Wire Baskets aren't just for bread! Our baskets are a great way to serve entrees, bread and sides while adding a casual touch to your serving presentation.

- For use with paper or fabric liners
- Heavy gauge Stainless Steel wire construction
- Stackable for easy storage and transport
- Easy to clean, dishwasher safe



g



d



f

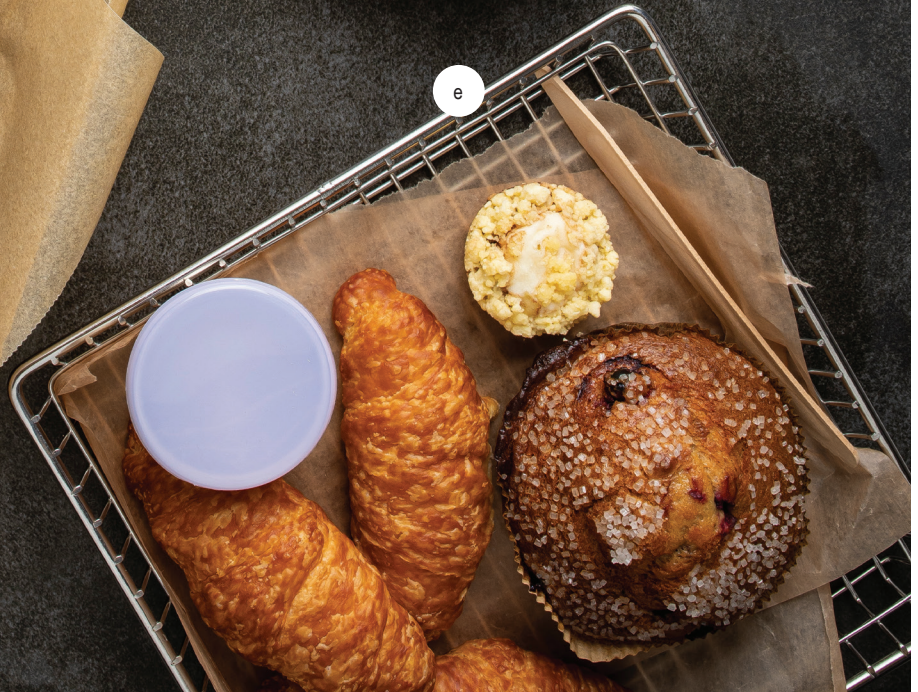

e

SHEET PAN & PIE PAN SERVERS

- Not just for baking; Sheet Pan Servers offer an alternative to serving large portions of chicken, smokehouse barbecue, or burgers
- Our new Pie Pan Servers are great for cooking and serving all in one pan! Ideal for baking pies, cakes and other desserts and entrees or for serving sandwiches, paninis and sides!
- Great for family style serving, catered events, or for use in high volume serving
- Stainless Steel servers are dishwasher safe; Aluminum servers are hand wash recommended



Our new 6" Pie Pan Servers are great additions to our existing servers and are great for cooking and serving all in one!



Item #	Description	Min Order
SHEET PAN SERVERS (Hand wash recommended)		
a. 913A	Fourth Size Aluminum, 19 GA, 13 x 9½"	1 ea
913AS	Fourth Size Aluminized Steel, 23 GA, 13 x 9½"	1 ea
1006AS	Eighth Size Aluminized Steel, 23 GA, 10 x 6"	1 ea
PIE PAN SERVERS		
ALUMINUM (Hand wash recommended)		
b. 11655	6" dia x 1" (0.7 mm Thickness)	1 ea
10545	9½" dia x 1" (0.7mm thickness)	1 ea
c. 10546	10½" dia x ¾" (0.7mm thickness)	1 ea
STAINLESS STEEL (Dishwasher safe)		
d. 11656	6" dia x 1" (0.5 mm Thickness)	1 ea
e. 10547	9½" dia x 1" (0.5mm thickness)	1 ea
f. 10548	10½" dia x ¾" (0.5mm thickness)	1 ea



Cost-effective way to dress your tabletop

CRACKLE COLLECTION™

Enhance your tabletop setting with our Crackle Collection of serving cups and platters, featuring a distinctively elegant "crackle" pattern in two colors: gold and black. The full assortment allows you to dress your tabletop and perfectly present your entrees, sides, desserts and more!

- Durable Aluminum construction
- Heat safe up to 150°F



add more
texture
to your table

Beautiful contrasting crackle exterior and hammered interior



Item # Description Capacity Min Order

SERVING CUPS, PLATTERS, BOWLS & SUGAR HOLDERS—CRACKLE PATTERN, ALUMINUM, BLACK POWDER COATED FINISH

a.	10702	Oval Bowl, 9¼ x 6¾ x 2½"	64 oz	1 ea
b.	10703	Oval Bowl, 6½ x 4¾ x 2¾"	28 oz	1 ea
c.	10736	Round Platter, 8½" dia x 2"	52 oz	1 ea
d.	10737	Square Snack Basket, 4 x 4 x 3¾"	21 oz	1 ea
e.	10738	Oval Sugar Packet Holder, 3¼ x 2¾ x 2½"	—	1 ea

SERVING CUPS, PLATTERS & SUGAR HOLDERS—CRACKLE PATTERN, ALUMINUM, GOLD POWDER COATED FINISH

g.	10704	Oval Bowl, 9¼ x 6¾ x 2½"	64 oz	1 ea
h.	10705	Oval Bowl, 6½ x 4¾ x 2¾"	28 oz	1 ea
i.	10740	Round Platter, 8½" dia x 2"	52 oz	1 ea
j.	10741	Square Snack Basket, 4 x 4 x 3¾"	21 oz	1 ea
k.	10742	Oval Sugar Packet Holder, 3¼ x 2¾ x 2½"	—	1 ea



PETAL COLLECTION™ BASKETS

Our new Petal Wire Serving Baskets add a unique flair to your setting. For use as bread baskets, side servers, breakfast settings and more!

- Available in varying shapes and styles
- Black Powder Coated Metal
- Hand Wash Recommended

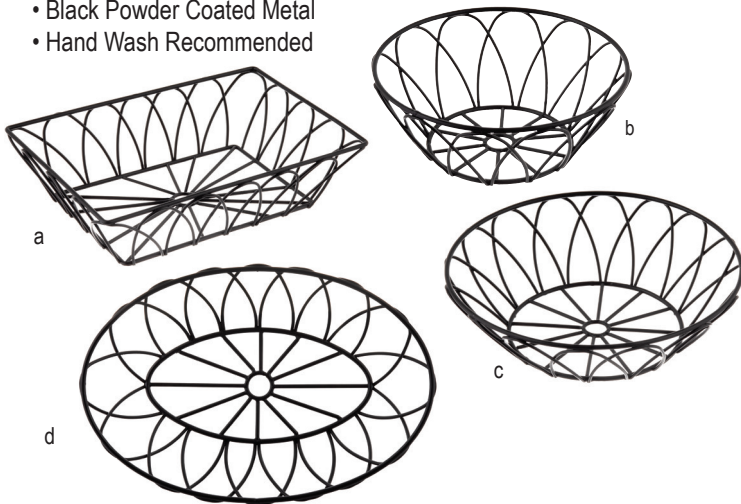

DELTA COLLECTION™ BASKETS

Our new Delta Collection™ modernizes your serving presentation. Providing an elegant and eye-catching way to serve bread, sides or display fruit and veggies.

- Available in (3) sizes: 6, 8, and 10" diameter
- Constructed of black powder coated steel
- Hand wash only

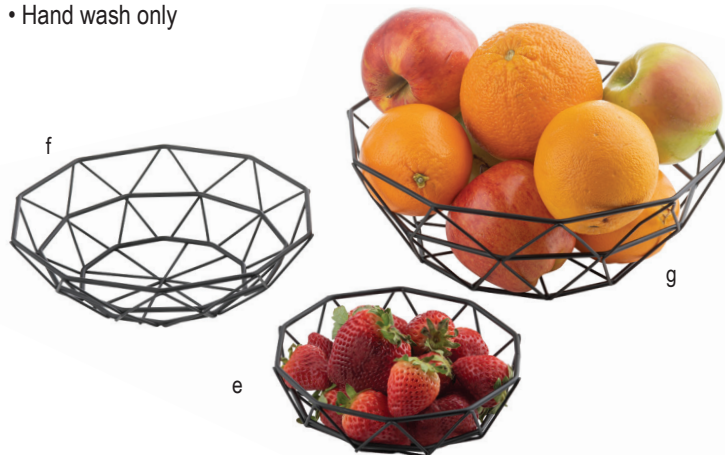

ARTISAN COLLECTION™ BASKETS

- Integrated ramekin holders fit 2 oz and 3 oz ramekins
- Ramekins not included



Item #	Description	Min Order/ Case Pack
PETAL COLLECTION™ BASKETS—BLACK POWDER COATED METAL		
a. 10537	Rectangular, 9 x 6 x 2½"	1 ea / 6 ea
b. 10534	Round, 6" dia x 2¼"	1 ea / 6 ea
c. 10535	Round, 8" dia x 2½"	1 ea / 6 ea
d. 10536	Oval, 9 x 6 x 2½"	1 ea / 6 ea
DELTA SERIES BASKETS—BLACK POWDER COATED STEEL		
e. 10462	Round, 6" dia x 2"	1 ea / 6 ea
f. 10463	Round, 8" dia x 2"	1 ea / 6 ea
g. 10464	Round, 10¼" dia x 3½"	1 ea / 6 ea
ARTISAN COLLECTION™ BASKETS—BLACK POWDER COATED STEEL		
h. BK171182	Round, 11 x 8¼ x 2"	1 ea / 6 ea
BK171372	Oval, 13¼ x 7¼ x 1¾"	1 ea / 6 ea
i. BK171172	Square, 11 x 7½ x 2"	1 ea / 6 ea
j. BK157	Round Cone, 4¾" dia x 6½"	1 ea / 6 ea
BK17508	Round, 8" dia x 2¼"	1 ea / 6 ea
BK17510	Round, 10" dia x 3"	1 ea / 6 ea
k. BK17409	Oval, 9¼ x 6¼ x 2¼"	1 ea / 6 ea
BK17410	Oval, 10 x 6¾ x 3¼"	1 ea / 6 ea
BK17412	Oval, 11¾ x 9 x 3½"	1 ea / 6 ea
l. BK11709	Oblong, 8¾ x 4 x 2"	1 ea / 6 ea
m. BK17209	Rectangular, 9 x 6 x 2½"	1 ea / 6 ea
BK17212	Rectangular, 12¼ x 9¼ x 3¼"	1 ea / 4 ea
BK17310	Square, 10 x 10 x 4"	1 ea / 6 ea
PARISIAN COLLECTION™ BASKETS—BLACK POWDER COATED METAL		
a. 10820	Round, 6" dia x 2¼"	1 ea
b. 10821	Round, 8" dia x 2¾"	1 ea
c. 10822	Oval, 9 x 6 x 3½"	1 ea

PARISIAN COLLECTION™ BASKETS

Expand your basket collection with these new Parisian Collection™ wire baskets with solid bottoms for additional versatility.

- Available in varying shapes and styles
- Black powder coated metal
- Hand wash recommended

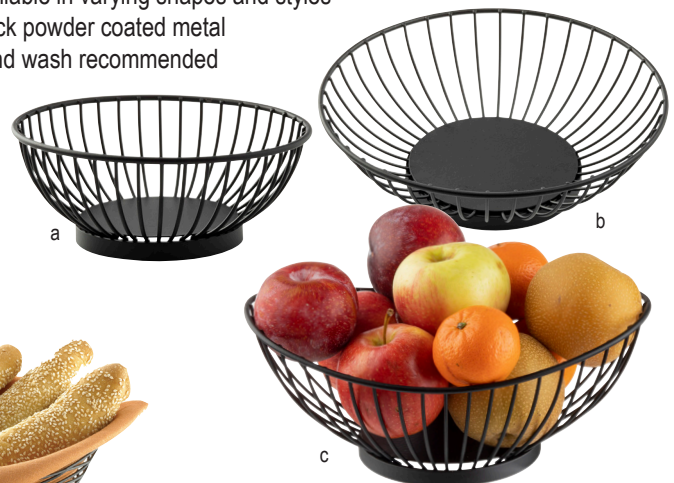

SERVING TOWERS

Add a unique spin to serving gourmet sliders, onion rings and pretzels with our new Serving Towers. Constructed of durable Stainless Steel (wire or solid brushed finish). Pretzel and Onion Ring Tower includes ramekin holders that hold our 3 and 4 ounce ramekins (melamine or Stainless Steel—ramekins not included).

- Perfect for gastro pubs, diners and fast-casual burger & BBQ
- Towers add height and character to your presentation and saves valuable table space
- Easy to clean, dishwasher safe



Item #	Description	Min Order/ Case Pack
SERVING TOWERS-STAINLESS STEEL		
a. 10460	Onion Ring Tower with Ramekin Holders, 8 1/4" dia x 13"	1 ea / 6 ea
b. 10461	Pretzel Tower with Ramekin Holders, 6" dia x 12"	1 ea / 6 ea
c. 10397	Slider Ring Tower with Base, 7" dia x 10"	1 ea / 2 ea

Design makes for safe and easy stacking of sliders



c

Base offers additional space for sides or sauce cups

Ramekins sold separately;
10460 and 10461 fits the following ramekins:
RAM3—3 oz Ramekin, Plain, Melamine
5072—4 oz Sauce Cup, Stainless Steel
5063—4 oz Sauce Cup, Flared Design, Stainless Steel



a

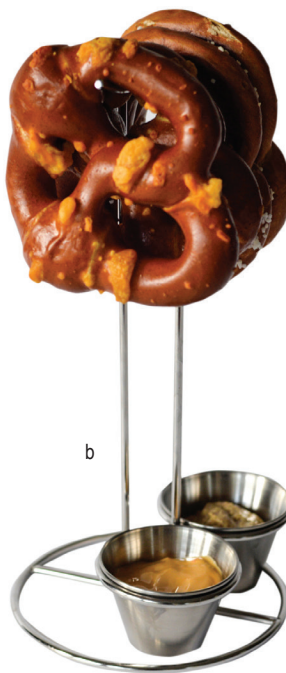

b

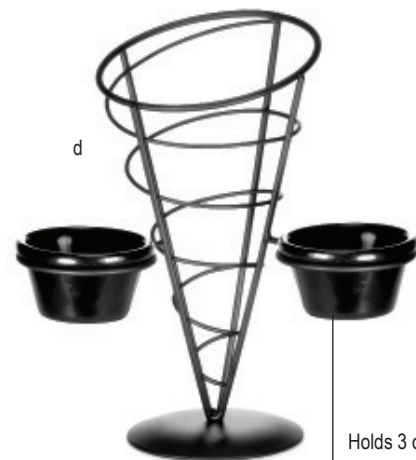

d

Holds 3 oz plain ramekins

For use with paper or fabric liners



e

VERTIGO COLLECTION™

- Serve up appetizers, sides or shareable dishes with these stylish serving baskets



Item #	Description	Capacity	Min Order/ Case Pack
VERTIGO COLLECTION™ SERVERS—BLACK POWDER COATED STEEL OR STAINLESS STEEL			
d. ACR259	5" dia x 9" Server, Includes (2) Ramekins (RAM3BK)	(2) 3 oz	1 ea / 4 ea
e. ACR57	5" dia x 7" Server, Includes (1) Ramekin (RAM3BK)	3 oz	1 ea / 6 ea



FORGE COLLECTION™ BASKETS

Perfect baskets for indoor and outdoor service that provide rustic style to your tabletop or buffet. They can also be used for grab & go service as well as placing a liner inside for tabletop service.

- Black Galvanized Steel
- Half size and full-size baskets fits in black Grab & Go displays
- Hand wash only



Elevate your table display in rustic style.



Item	Description	Min Order	List Price (\$)
FORGE COLLECTION™-STEEL (GALVANIZED), BLACK			
a.	11692 ▶ Round, 8" dia x 2¾"	1 ea	6.50 ea
b.	11693 ▶ Round, 10¼" dia x 4"	1 ea	9.50 ea
c.	11694 ▶ Rectangular, 10¼ x 6¼ x 3¼"	1 ea	7.00 ea
d.	11695 ▶ Rectangular, 12¾ x 10½ x 4¼", Half Size, Fits on Grab & Go Display	1 ea	26.00 ea
e.	11696 ▶ Rectangular, 20¾ x 12¾ x 4¾", Full Size, Fits on Grab & Go Display	1 ea	44.00 ea



SQUEEZE BOTTLE CADDY
11846
Holds (4) 63 mm bottles
2¾" dia bottles (7¼ x 7 x 6¾")

(6) Bottle Caddy also available
11847
See [page 247](#) in our catalog for
our complete Forge Collection™

Item #	Description	Min Order
FAJITA SERVING BOARDS†		
a. 10709	Rectangular, 18½ x 8¾ x ¾"	1 ea
b. 10710	Oval, 17 x 12¼ x ¾"	1 ea
REPLACEMENT PARTS & ACCESSORIES		
c. TW771	Tortilla Warmer, Black, Polypropylene, for 6" Tortillas	1 ea
TASTING FLIGHTS- BLACK POWDER COATED STEEL†		
d. *WF200BK	Black Powder Coated, 7½" dia x 14¼"	1 ea

†Hand wash only
*Available as Cash & Carry



a

Looking for the perfect fajita serving presentation?

Our Acacia Serving Boards are available in rectangular and oval shapes and with cut-outs for ramekins and oval sizzle platters.

- Platter #10746 (page 201), ramekins (assorted) are sold separately
- Oval Au Gratin #CW30100 (page 200)
- Warm, natural Acacia Wood to allow for easy, safe and convenient fajita transportation to and from the table
- Dimensions listed above
- Hand wash only, do not submerge in water
- Assorted Ramekins that fit platters: RAM3BK, RAM3RBK, RAM3RW, 240004, 5063, 5073 (sold separately)



a

b

c

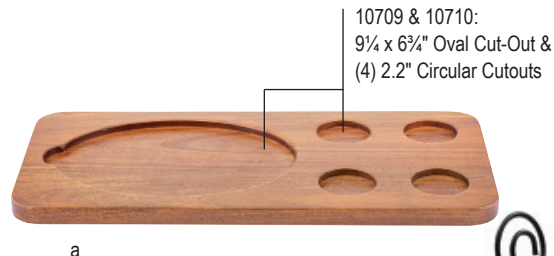

a

10709 & 10710:
9¼ x 6¾" Oval Cut-Out &
(4) 2.2" Circular Cutouts

VERTICAL TASTING FLIGHTS

- Attractive serving solution for condiment cups and wine glasses
- Raised design offers accessibility and saves valuable table space
- Holds wine glasses up to 5" in diameter w/ a maximum stem length of 5"
- Inside ring diameter 2¼"
- Holds the following sauce cups: 5066, 5068, 240010, GRSS3, 5071, 5072, 5063, 10768, & 10769



d



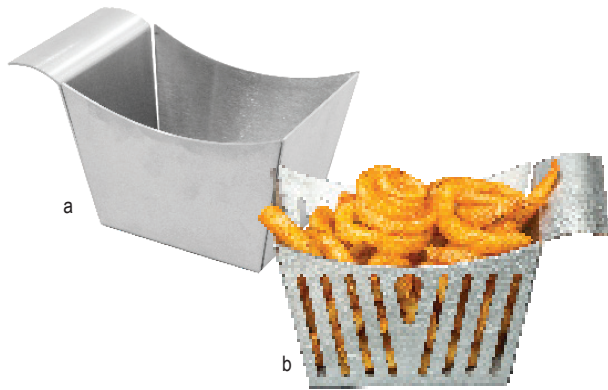

Item #	Description	Min Order
SIDE BASKETS & TRAYS—STAINLESS STEEL		
a. SSB	Solid Basket, 5 $\frac{3}{8}$ x 3 $\frac{3}{8}$ x 3 $\frac{1}{8}$ "	1 ea
b. SPB	Stamped Pinstriped Basket, 5 $\frac{3}{8}$ x 3 $\frac{3}{8}$ x 3 $\frac{1}{8}$ "	1 ea
c. SCB	Stamped Circle Basket, 5 $\frac{3}{8}$ x 3 $\frac{3}{8}$ x 3 $\frac{1}{8}$ "	1 ea
d. 7177	Stamped Circle Round Basket, 7 $\frac{7}{8}$ " dia x 3 $\frac{1}{8}$ "	1 ea
e. SCB965	Stamped Circle Rectangular Tray, 9 x 6 $\frac{1}{2}$ x 1 $\frac{1}{4}$ "	1 ea
SCB139	Stamped Circle Rectangular Tray, 13 x 9 x 1 $\frac{1}{4}$ "	1 ea



TACO TAXI™ SERVERS—STAINLESS STEEL BRUSHED FINISH, CIRCLE PATTERN		
TRSP12	Holds 1-2 Tacos, 3 $\frac{3}{8}$ x 2 $\frac{1}{4}$ x 1 $\frac{1}{2}$ "	1 ea
TRSP23	Holds 2-3 Tacos, 5 $\frac{3}{8}$ x 2 $\frac{1}{4}$ x 1 $\frac{1}{2}$ "	1 ea
f. TRSP34	Holds 3-4 Tacos, 7 $\frac{7}{8}$ x 2 $\frac{1}{4}$ x 1 $\frac{1}{2}$ "	1 ea

This cut-out, stamped design comes full circle!
 Coordinate your service with trays, side baskets and taco taxis into one totally-hole presentation

See our full assortment of taco taxis on page 185 of our catalog

FRY CUPS

Serve fries, onion rings and other sides with our range of Stainless Steel Serving Side Cups.

- Available in three finishes: Brushed, Hammered and Stonewashed
- 13 ounce capacity
- Easy to clean, dishwasher safe



Item #	Description	Capacity	Min Order
FRY CUPS—STAINLESS STEEL			
g. 10676	Square Fry Cup, Brushed Finish	13 oz	1 ea
h. 10678	Square Fry Cup, Hammered Finish	13 oz	1 ea
i. 10680	Square Fry Cup, Stone Washed Finish	13 oz	1 ea



TACO TAXI™

- Prep and serve your hard or soft shell taco creations in style
- Perfectly designed to cradle your stuffed creations; use with 4"-7" tortillas. Also great for hard shell tacos, bao and lettuce wraps
- Stainless Steel, Melamine or Wood
- Melamine servers are safe for temperatures up to 212°F
- Stainless Steel servers are safe for temperatures up to 500°F
- Two-piece Disposable Taco Taxi design comes flat in packaging, assembles easily (for sanitary reasons, use one time only)



See how easy it is to assemble our poplar taxis:

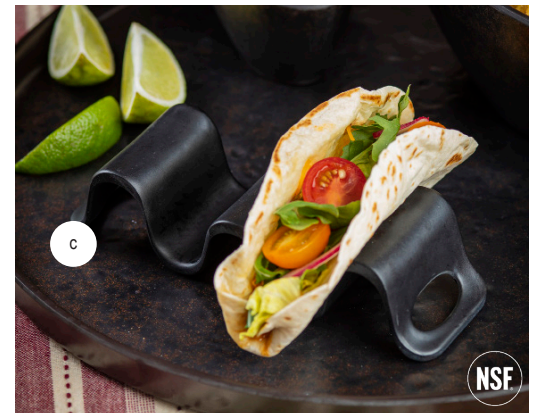

Item #	Description	Min Order
TACO TAXI™ SERVERS—POPLAR WOOD		
a. *10516	Holds 1 Taco, X-Shape Two-Piece Design, 3½ x 2½ x 1¾", (Pack of 50)	1 pk
TACO TAXI™ SERVERS—MELAMINE, NSF®		
b. 10277BK	Holds 1-2 Tacos, 4¾ x 2¼ x 1⅝"	1 ea
c. 10278BK	Holds 2-3 Tacos, 7 x 2¼ x 1⅝"	1 ea
d. 10279BK	Holds 3-4 Tacos, 9¾ x 2¼ x 1⅝"	1 ea
TACO TAXI™ SERVERS—STAINLESS STEEL WIRE		
TRW12	Holds 1-2 Tacos, 3⅝ x 2¼ x 1½"	1 ea
e. TRW23	Holds 2-3 Tacos, 5⅝ x 2¼ x 1½"	1 ea
f. TRW34	Holds 3-4 Tacos, 7¾ x 2¼ x 1½"	1 ea
TACO TAXI™ SERVERS—STAINLESS STEEL BRUSHED FINISH, SOLID		
TRS12	Holds 1-2 Tacos, 3⅝ x 2¼ x 1½"	1 ea
TRS23	Holds 2-3 Tacos, 5⅝ x 2¼ x 1½"	1 ea
g. TRS34	Holds 3-4 Tacos, 7⅝ x 2¼ x 1½"	1 ea
TACO TAXI™ SERVERS—STAINLESS STEEL BRUSHED FINISH, CIRCLE PATTERN		
TRSP12	Holds 1-2 Tacos, 3⅝ x 2¼ x 1½"	1 ea
TRSP23	Holds 2-3 Tacos, 5⅝ x 2¼ x 1½"	1 ea
h. TRSP34	Holds 3-4 Tacos, 7⅝ x 2¼ x 1½"	1 ea

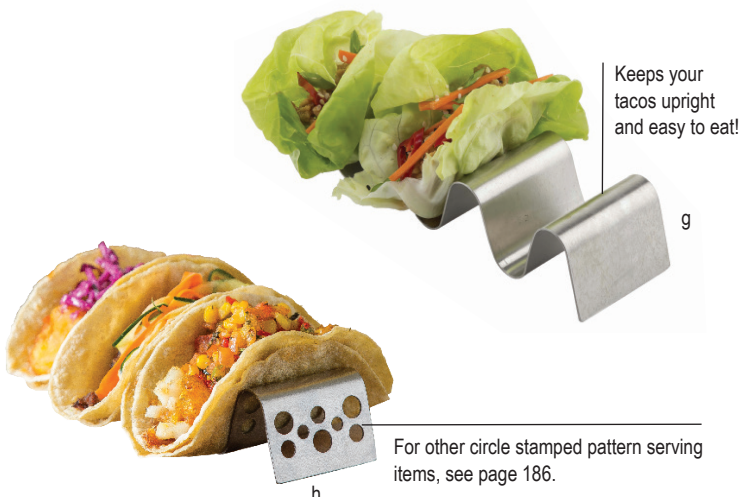

MELAMINE RAMEKINS

- Versatile ramekins in a range of colors and sizes
- Ideal for serving side dishes, dressings and for easy portion control
- Nests together for easy storage



Item #	Description	Color	Capacity	Min Order
ROUND RAMEKINS—MELAMINE				
a.	RAM2RDB Straight, 2½" dia x 1", Bone	White	2 oz	12 ea
b.	RAM2W Tapered, 2⅞" dia x 1½", White	White	2 oz	12 ea
	RAM2BK Tapered, 2⅞" dia x 1½", Black	Black	2 oz	12 ea
c.	RAM3W Tapered, 3⅞" dia x 1¼", White	White	3 oz	12 ea
	RAM3BK Tapered, 3⅞" dia x 1¼", Black	Black	3 oz	12 ea
	RAM1FBK Tapered, Fluted, 2¼" dia x 1", Black	Black	1 oz	12 ea
	RAM2RW* Round, Ribbed, 2⅞" dia x 1¼", White	White	2 oz	12 ea
	RAM2RBK* Round, Ribbed, 2⅞" dia x 1¼", Black	Black	2 oz	12 ea
	RAM3RW* Round, Ribbed, 3⅞" dia x 1½", White	White	3 oz	12 ea
	RAM3RBK* Round, Ribbed, 3⅞" dia x 1½", Black	Black	3 oz	12 ea
	RAM4RW* Round, Ribbed, White	White	4 oz	12 ea
	RAM4RBK* Round, Ribbed, 3⅞" dia x 1½", Black	Black	4 oz	12 ea
SQUARE RAMEKINS—MELAMINE				
	RAMS2W* Square, Ribbed, 2⅞" x 2⅞" x 1⅞", White	White	2 oz	12 ea
	RAMS2BK* Square, Ribbed, 2⅞" x 2⅞" x 1⅞", Black	Black	2 oz	12 ea
	RAMS3W* Square, Ribbed, 3⅞" x 3⅞" x 1½", White	White	3 oz	12 ea
	RAMS3BK* Square, Ribbed, 3⅞" x 3⅞" x 1½", Black	Black	3 oz	12 ea
	RAMS4W* Square, Ribbed, 3¼" x 3¼" x 1⅞", White	White	4 oz	12 ea
	RAMS4BK* Square, Ribbed, 3¼" x 3¼" x 1⅞", Black	Black	4 oz	12 ea
d.	MB21 Square, Smooth White	White	2 oz	12 ea



We offer a variety of sizes and styles ready to accommodate your dips, sauces and condiments

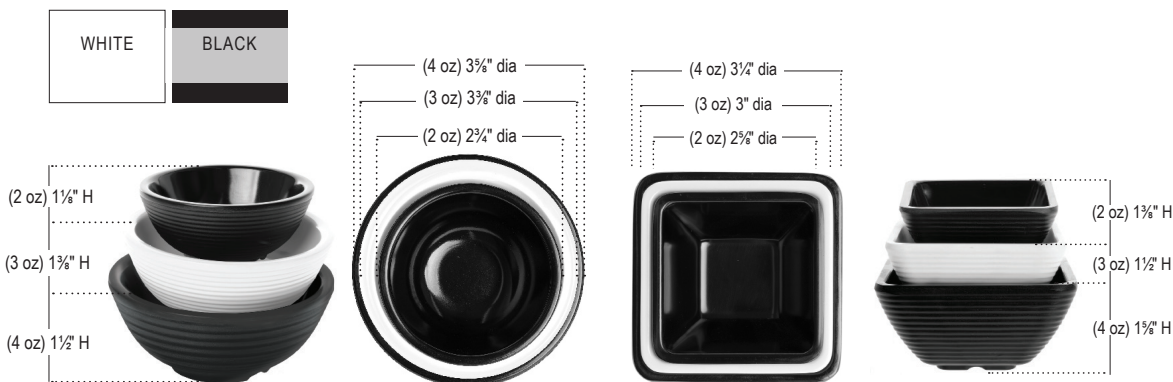

STAINLESS STEEL RAMEKINS WITH LIDS

Keep your condiments safely sealed with our range of ramekins with lids, replacement lids also available. Perfect for single serve sauces and sides or for grab & go or pick-up prepacked meals.

- Three capacities available - 2½ oz, 3 oz and 5 oz
- Ideal for pre-portioning table service condiments
- Cash & carry packs includes (6) ramekins and (6) lids
- Ramekins are heat safe up to 500°F; plastic lids are heat safe up to 175°F
- Plastic lids are dishwasher safe, top rack only



View our video on our Stainless Steel Ramekins with Lids

SAUCE BOATS STACKABLE & TRADITIONAL

- Portion-sized sauce boats, in a variety of sizes
- Stackable version is designed for easy storage
- Stainless Steel version has a brushed finish to hide fingerprints
- Traditional version has a classic design available in two capacities
- Now available in a melamine



Item #	Description	Capacity	Min Order
SAUCE CUPS—STAINLESS STEEL			
5066	Tapered, 2½" dia x 1"	1½ oz	12 ea
*C5066	Tapered, 2½" dia x 1" (12 per pack)	1½ oz	8 pk
5068	Tapered, 2¾" dia x 1½"	2 oz	72 ea
*C5068	Tapered, 2¾" dia x 1½" (12 per pack)	2 oz	8 pk
5067	Tapered, 2¾" dia x 1½"	2½ oz	12 ea
*C5067	Tapered, 2¾" dia x 1½" (12 per pack)	2½ oz	8 pk
240010	Tapered Cup, Flared Rim, 2¾" dia x 1½"	3 oz	12 ea
5071	Tapered, 2¾" dia x 1½"	3 oz	12 ea
5072	Tapered, 2¾" dia x 2"	4 oz	12 ea
5073	Tapered, 3⅝" dia x 2¼"	6 oz	12 ea
5063	Flared, 3⅝" dia x 1½"	4 oz	12 ea
5064	Flared, 3¾" dia x 1½"	6 oz	12 ea
RAMEKINS—STAINLESS STEEL WITH PLASTIC LIDS			
*H5069	Tapered, 2½" dia x 1¼" (Pack of 6)	2½ oz	6 pk
a. *10769	Tapered, 2⅞" dia x 2" (Pack of 6)	3 oz	6 pk
*10773	Tapered, 3½" dia x 2⅞" (Pack of 6)	5 oz	6 pk
BRICKHOUSE COLLECTION™—STAINLESS STEEL			
GRSS1	Tapered, 2¾" dia x 1"	1½ oz	12 ea
b. GRSS2	Tapered, 2¼" dia x 1¼"	2½ oz	12 ea
GRSS3	Tapered Cup, Flared Rim, 2¾" dia x 1¼"	3 oz	12 ea
SAUCE BOATS—18/8 STAINLESS STEEL			
c. 9803	Stackable	3 oz	1 ea
9805	Stackable	5 oz	1 ea
9808	Stackable	8 oz	1 ea
9812	Stackable	12 oz	1 ea
7803	Traditional	3 oz	1 ea
d. 7805	Traditional	5 oz	1 ea
SAUCE BOATS—MELAMINE, WHITE			
e. 11677	Stackable	3 oz	1 ea
f. 11678	Stackable	5 oz	1 ea
g. 11679	Stackable	8 oz	1 ea
h. 11680	Stackable	12 oz	1 ea

*Available as Cash & Carry

better burger condiments collection™



a / b / c

Our soufflé cups look like the traditional paper cups updated in durable melamine. A fun way to present dipping sauces and sides.



d / e

Our sauce cups are ideal for portion controlled single serve condiments with a nostalgic flair.

See the rest of the Better Burger Collection™ on pages 156-157

MELAMINE BOWLS & SOUFFLE & SAUCE CUPS

- Versatile ramekins in a range of sizes and styles
- Ideal for serving side dishes, dressings and for easy portion control
- Nests together for easy storage



Item #	Description	Capacity	Min Order
BETTER BURGER COLLECTION™ SOUFFLE CUPS—MELAMINE, WHITE			
a.	240003 2 oz, 2 1/8" dia x 1 3/8"	2 oz	12 ea
b.	240004 3 oz, 2 3/8" dia x 1 7/8"	3 oz	12 ea
c.	240005 6 oz, 3 1/8" dia x 2 3/8"	6 oz	12 ea
BETTER BURGER COLLECTION™ SAUCE CUPS—MELAMINE, WHITE			
d.	240008 2 oz, 2 5/8 x 2 1/8 x 1 1/4"	2 oz	12 ea
e.	240009 3 oz, 3 x 2 1/2 x 1 3/8"	3 oz	12 ea

single servers

MELAMINE MINI SERVERS

- Great for sampling, buffet and catering, tastings or desserts
- Dishwasher safe melamine gives almost immediate savings over single use serving pieces
- Have the look of more expensive porcelain pieces, without the breakage

Item #	Description	Capacity	Min Order
MINI SERVING DISHES—MELAMINE, WHITE			
f.	10311W Round Plate, 4" dia x 1"	3 3/4 oz	24 ea
g.	10312W Stacking Bowl, 3" dia x 1 1/4"	3 oz	12 ea
h.	10313W Oval Bowl, 3 1/2 x 2 3/8 x 1 1/8"	3/4 oz	24 ea
i.	10314W Oval Bowl, 4 x 2 1/8 x 7/8"	1 1/2 oz	24 ea
j.	10315W Rounded Square Bowl, 2 3/4 x 2 3/4 x 7/8"	1 1/2 oz	24 ea
k.	10316W Square Bowl, 2 3/4 x 2 3/4 x 1"	2 1/2 oz	24 ea
l.	10317W Spoon, 3 3/4 x 2 1/8 x 2 1/8"	1 oz	24 ea

Mini servers displayed on Pulito Collection™ 13 1/8" dia" Round Platter. See complete Pulito Collection™ offering on page 155.



f



g



h



i



j



k



l



Make a big impact with these mini servers.

MELAMINE MINI SERVERS

Our melamine Mini Servers are now available in black. They are great for sampling, buffet and catering, tastings or desserts.

- Melamine construction with the look of more expensive porcelain pieces, without the breakage
- Safe for temperatures up to 212°F
- Easy to clean, dishwasher safe



Item	Description	Capacity	Min Order	List Price (\$)
MINI SERVERS—MELAMINE, BLACK				
a.	10311BK Round Plate, 4" dia x 1"	3¼ oz	24 ea	1.16 ea
b.	10312BK Stacking Bowl, 3" dia x 1¼"	3 oz	12 ea	1.40 ea
c.	10313BK Oval Bowl, 3½ x 2¾ x 1½"	¾ oz	24 ea	1.16 ea
d.	10314BK Oval Bowl, 4 x 2½ x ¾"	1½ oz	24 ea	1.16 ea
e.	10315BK Rounded Square Bowl, 2¾ x 2¾ x ¾"	1½ oz	24 ea	1.16 ea
f.	10316BK Square Bowl, 2¾ x 2¾ x 1"	2½ oz	24 ea	1.26 ea
g.	10317BK Spoon, 3¾ x 2½ x 2½"	1 oz	24 ea	1.16 ea





a

GASTRONORM SERVING & DISPLAY TRAYS

- These trays bring a refined rustic feel to your serving presentation
- Designed to fit standard full or half size food pans
- Features solid plank bottom and handles for convenient use
- Full size crate fits standard 12 x 18" placemats



Item #	Description	Min Order/ Case Pack
ACACIA WOOD		
a. CRATESB11	Full Size, Solid Bottom, Acacia 20 $\frac{1}{8}$ x 12 $\frac{3}{4}$ x 2 $\frac{3}{4}$ "	1 ea / 8 ea
BLACK PAINTED WOOD		
CRATESB11BK	Full Size, Solid Bottom, Acacia 20 $\frac{1}{8}$ x 12 $\frac{3}{4}$ x 2 $\frac{3}{4}$ "	1 ea / 8 ea



b

Rubber non-slip rings to
keep straps & tray in place



TRAY STANDS

- Rubber slip-proof top rings
- Tall tray stand reduces back strain and fatigue

Item #	Description	Min Order/ Case Pack
TRAY STANDS—WOOD BLACK OR MAHOGANY FINISH		
22	Mahogany, 17 x 16 x 38"	1 ea
b. 21	Mahogany, 17 x 16 x 32 $\frac{1}{2}$ "	1 ea
10399	Black, 16 $\frac{5}{8}$ x 16 $\frac{1}{2}$ x 32"	1 ea
c. 11520	Black, 17 x 16 x 38"	1 ea
31	Mahogany, Spindle Design, 17 $\frac{3}{4}$ x 16 $\frac{1}{2}$ x 31"	1 ea
d. 11521	Black, Spindle Design, 17 $\frac{3}{4}$ x 16 $\frac{1}{2}$ x 31"	1 ea
TRAY STANDS—CHROME PLATED OR BLACK POWDER COATED METAL		
23	Single Bar, Chrome Plated, 17 $\frac{1}{4}$ x 17 $\frac{1}{4}$ x 29 $\frac{3}{4}$ "	1 ea
e. 24	Double Bar, Chrome Plated, 18 $\frac{1}{4}$ x 16 $\frac{1}{2}$ x 31 $\frac{3}{4}$ "	1 ea
f. 23BK	Single Bar, Black, 17 $\frac{1}{4}$ x 17 $\frac{1}{4}$ x 29 $\frac{3}{4}$ "	1 ea
24BK	Double Bar, Black, 18 $\frac{1}{4}$ x 16 $\frac{1}{2}$ x 31 $\frac{3}{4}$ "	1 ea



c



d



e



f

Heavy tubular
construction

FRESH STYLES in TABLETOP

SUGAR PACKET HOLDERS

- Serve pre-portioned sugar and sweetener packets or tubes
- Available in a variety of materials and styles to fit any decor

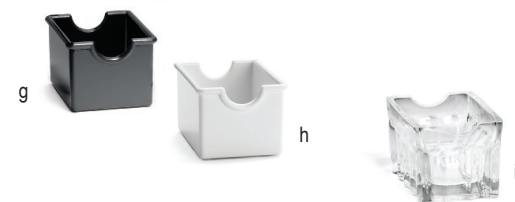

Item #	Description	Min Order
PREMIUM SUGAR PACKET HOLDERS—BRUSHED STAINLESS STEEL		
a. 1155	2" dia x 2¾" Round	1 ea
b. 1156	2 x 2 x 2¾" Square	1 ea
c. 1157	¾ x 2½ x 1¾" Rectangular	1 ea
PREMIUM SUGAR PACKET HOLDERS—BLACK POWDER COATED STEEL		
d. BK155	2" dia x 2½" Round, Artisan Collection™	12 ea
e. BK156	¾ x 2½ x 2" Rectangular, Artisan Collection™	12 ea
f. BK256	¾ x 2½ x 2" Rectangular, Mediterranean Collection™	12 ea
ASSORTED SUGAR PACKET HOLDERS*		
g. 56B	¾ x 2½ x 2" Black, Polystyrene	24 ea
h. 56W	¾ x 2½ x 2" White, Polystyrene	24 ea
i. *H121	¾ x 2½ x 2½" Fluted Glass	12 ea
j. *C56W	¾ x 2½ x 2" White, Polystyrene (6 per Pack)	1 pk
k. *10308	¾ x 2½ x 2" Clear, Polystyrene (6 per Pack)	1 pk
l. *10309	¾ x 2½ x 2" Black, Polystyrene (6 per Pack)	1 pk
m. 58MF	¾ x 2¾ x 1¾" 18/8 S/S, Mirror Finish	12 ea
n. 58BF	¾ x 2¾ x 1¾" 18/8 S/S, Brushed Finish	12 ea
SUGAR PACKET HOLDERS—CRACKLE COLLECTION™—POWDER COATED ALUMINUM		
o. 10738	¾ x 2½ x 2½", Oval, Black	1 ea
p. 10739	1¼" dia x 2¾", Round Tube, Black	1 ea
10742	¾ x 2½ x 2½", Oval, Gold	1 ea
10743	1¼" dia x 2¾", Round Tube, Gold	1 ea
SUGAR PACKET HOLDERS—SIERRA TABLETOP COLLECTION™—MELAMINE		
q. 10420	Sugar Packet Holder, ¾ x 2¾ x 2½"	12 ea
r. 10421	Sugar Jar with Lid, 6 oz, 3⅝" dia x 4¼"	12 ea
SUGAR PACKET HOLDERS—PULITO COLLECTION™—MELAMINE		
s. 10415	Sugar Packet Holder, 4 x 3¼ x 2"	12 ea
t. 10416	Sugar Jar with Lid, 3" dia x 4⅝"	12 ea

*Available as Cash & Carry
†Hand wash only

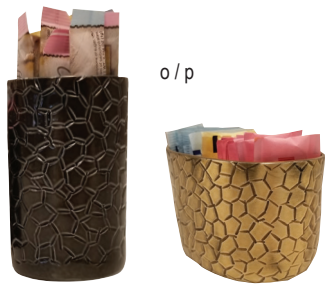

COLD BEVERAGE DISPENSERS



b



2½ & 4½ Gallon capacities

Packaged for Cash & Carry

7¼" Faucet clearance

An update to the traditional beverage dispenser with a modern straight wall design

UPSCALE

Serve bulk beverages with our Upscale Beverage Dispensers. Each dispenser features a Tritan® Reservoir with brushed Stainless Steel lid and base. Available in multiple capacities.

- Durable BPA-Free Tritan® Reservoir
- Removable Stainless Steel ice core and infuser tube
- Hand wash recommended



Hands free faucet option available (10626)



5 Gallon capacity

Other capacities available

Durable BPA-Free Tritan® Reservoir

7" Faucet clearance

Removable infuser tube

Removable ice core tube



Removable ice core tube fits into removable infuser tube

Item #	Description	Capacity	Min Order
UPSCALE BEVERAGE DISPENSERS—STAINLESS STEEL, BPA-FREE TRITAN® PLASTIC WITH NICKEL PLATED ABS FAUCET			
a. 7515	Single, 8¼ x 9 x 17¼" (5½" faucet clearance)	1¼ Gal	1 ea
b. 10450	Single, 9¾ x 12½ x 19¾" (6¾" faucet clearance)	2½ Gal	1 ea
c. 10451	Single, 11 x 13½ x 23¾" (7¼" faucet clearance)	4½ Gal	1 ea
75	Single, 10¾ x 11½ x 19½" (6¾" faucet clearance)	2½ Gal	1 ea
d. 85	Single, 12¼ x 13¼ x 24½" (7" faucet clearance)	5 Gal	1 ea
REPLACEMENT PARTS (Not packaged for Cash & Carry)			
75F	Heavy Duty Nickel Plated ABS	-	1 ea
75FM	Universal Stainless Steel Faucet	-	1 ea
e. 10626	Universal Faucet, Black (Fits ALL Plastic & Glass Beverage Dispensers)	-	1 ea
75B	Base for 75, S/S	-	1 ea
75C	Cover for 75, S/S	-	1 ea
75G	Gasket Set for 75 & 85	-	1 ea
75IC	Infuser for 75	-	1 ea
75N	Nut for 75F Faucet for 75 & 85	-	1 ea
75R	2.5 Gal Reservoir for 75, BPA-Free	-	1 ea
75T	Ice Core Insert, S/S for 75	-	1 ea
85B	Base, S/S for 85	-	1 ea
85C	Cover for 85, S/S	-	1 ea
85FH	Heavy Duty Faucet for 85, Black	-	1 ea
85IC	Infuser for 85	-	1 ea
85R	5 Gal Reservoir for 85, BPA-Free	-	1 ea
85T	Ice Core Insert, S/S for 85	-	1 ea

SILHOUETTE™



Removable infuser tube

Durable BPA-Free Tritan® reservoir

NSF® faucet

8½" Faucet clearance

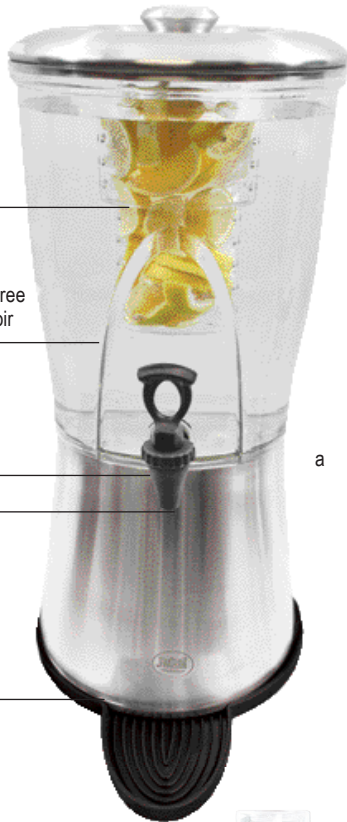

infuse more serving options and opportunities from chilled to flavored beverages in our Upscale, Silhouette™ and Stackable plastic beverage dispensers. Assorted styles available in multiple capacities for small to large groups.



Item #	Description	Capacity	Min Order
SILHOUETTE™ BEVERAGE DISPENSERS—STAINLESS STEEL, BPA-FREE TRITAN® PLASTIC			
a. N175	NSF® Single, 11¼ x 12¾ x 23½" (8½" faucet clearance)	3½ Gal	1 ea
PLASTIC STACKABLE BEVERAGE DISPENSERS			
b. BAD1500	9½ x 10½ x 13½" (4¾" faucet clearance)	1½ Gal	1 ea
c. 10961	Two-Tiered Stackable Beverage Dispenser, 12¼ x 9¾ x 15", Styrene Acrylonitrile (SAN) (4¼" faucet clearance from base to 1st faucet; 8½" faucet clearance from base to 2nd faucet)	(2) 1 Gal	1 ea
REPLACEMENT PARTS & ACCESSORIES (Not packaged for Cash & Carry)			
N175F	NSF® Faucet for N175, Polypropylene Can be used on any dispenser shown on this and page 107.	-	1 ea
d. BDGF	Faucet for BAD1500 and BDG Glass Beverage Dispensers	-	1 ea
175INF	Infuser for 175 & N175, Tritan™ BPA-Free	-	1 ea
175LID	Lid, S/S (For 175 & N175) Includes Plastic Insert	-	1 ea
175R	Reservoir for 175 and N175, BPA-Free	-	1 ea
175SB	Base, S/S for 175 & N175	-	1 ea

FAUCET BEVERAGE DISPENSER

10626	Fits: 10961, 75, 85, BDG1000, BDG2000, BDG3000, 10699, BAD1500, 10090, N175, 953, H953, 954, 955, 1053, 1054, 1055, 353DP, H353DP, 354DP, 356DP, TW53DP, TW33DP, & TW54DP
BDGF	Fits N175, BAD1500, 10961, 7515, 10450, 10451, 75, 85 & BDG Glass Beverage Dispensers
N175F	Fits N175, BAD1500, 10961, 7515, 10450, 10451, 75, & 85
75F	Fits N175, BAD1500, 10961, 7515, 10450, 10451, 75, & 85
71F	Fits 71 & 72
75FM	Fits N175, BAD1500, 10961, 7515, 10450, 10451, 75, & 85

Stackable design, ideal solution for serving a variety of drinks

Compact and lightweight, perfect for smaller spaces

b

(2) BAD1500 Shown Stacked



Replacement faucet available



Stack & serve two beverages at once

Use two for multi-beverage options

Use one for smaller service

Includes base to elevate

BPA FREE



INFUSION PITCHERS

- Infuser for fresh herbs and fruits to add a refreshing twist to water
- Disassembles for easy cleaning



ICE CORE PITCHER



Remington Collection™ Pitcher features base, ice guard & rice pattern



PREMIUM SERVERS



Highly polished Stainless Steel

BEVERAGE PITCHERS

BPA FREE



Lid features free flow and ice guard

Item #	Description	Capacity	Min Order
INFUSION PITCHERS—SAN PLASTIC, CLEAR			
a.	PP322FIN* Infusion Pitcher with Lid, SAN Plastic	2 qt	1 ea
ICE CORE PITCHERS—POLYCARBONATE			
b.	319 Pitcher with Center Ice Core	2 qt	1 ea
	328 Pitcher with Center Ice Core	3 qt	1 ea
REPLACEMENT PARTS			
	319IC Ice Core for 319 & 328	-	1 ea
	319INF Infuser Tube for 319 & 328	-	1 ea
	319T 2-pc Lid for 319	-	1 ea
	328T 2-pc Lid for 328	-	1 ea
PREMIUM WATER SERVERS—18/8 STAINLESS STEEL, MIRROR FINISH			
c.	202 Pitcher	2 qt	1 ea
	203 Pitcher	3 qt	1 ea
d.	300 Pitcher, Ice Guard	2 qt	1 ea
e.	RP68 Remington Collection™ Pitcher with Base, Ice Guard	2 qt	1 ea
BEVERAGE PITCHERS—SAN PLASTIC, CLEAR			
f.	364 Clear Pitcher	60 oz	1 ea
g.	PP321 Pitcher with Lid	2 qt	1 ea
PLASTIC MASON JAR WITH LID			
h.	10858* Jar with Lid	8 oz	1 ea
i.	10859* Jar with Lid	16 oz	1 ea
j.	10860* Jar with Lid	32 oz	1 ea

PLASTIC MASON JARS

Our multi-purpose Plastic Mason Jars are available in (3) different capacities to suit a variety of uses for table service, bar or grab & go carry stations. Ideal for serving and storing cocktails, fresh pressed juices, fruits, veggies, desserts, smoothies and more!

- Great for indoor and outdoor beverage serving
- Air-tight matte plated plastic lid allows for leak-safe storage
- For cold beverage and food serving and storage only
- Plated plastic tops also fit standard glass mason jars



Infuse... if you choose

tasteful carafes and pitchers from inside dining to outdoor events



Gravity pour lid filters infused beverage out; keeps fruit in

BEVERAGE CARAFES



f

Versatile, break-resistant and elegant design

Lid snaps closed for a tight seal

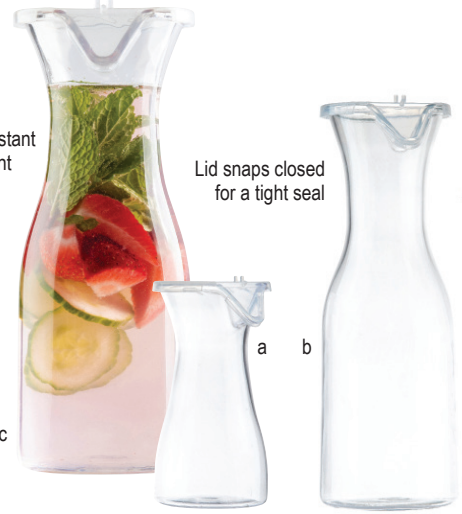

Great way to serve beverages, salad dressings, condiments and more



d



3-Hole Template (page 247) holds both 19 oz and 36 oz carafes or our 32 oz squeeze bottles (sold separately). Template fits standard 1/3 Size Food Pans (not included).



g

h

j

i

Item #	Description	Capacity	Min Order
POLYCARBONATE CARAFE WITH POLYPROPYLENE LID			
a. *10715	Carafe with Lid, Plastic	11 oz	1 ea
b. *10716	Carafe with Lid, Plastic	19 oz	1 ea
c. *10717	Carafe with Lid, Plastic	36 oz	1 ea
TEMPLATE-STAINLESS STEEL			
d. 10817	Template for 19 and 36 oz Carafes & 32 oz Squeeze Bottles, (3) 85mm Holes, Fits 1/3 Size Food Pans (not included)		1 ea
BEVERAGE CARAFES-PLASTIC, CLEAR			
e. *10111	Gravity Pour Carafe with Strainer	1¼ Qt	1 ea
f. *10110	Swirl Carafe with Stopper	1½ Qt	1 ea
g. *11799	Clear Carafe with Lid	34 oz	1 ea
h. *11800	Honeycomb Carafe with Lid	34 oz	1 ea
i. *11801	Fluted Carafe with Lid	34 oz	1 ea
j. *11802	Tapered Carafe with Lid	34 oz	1 ea
REPLACEMENT PARTS & ACCESSORIES			
10866	Replacement Lid for 10715 & 10716		1 ea
10867	Replacement Lid for 10717		1 ea

*Available as Cash & Carry

TO-GO BEVERAGE POUCHES

Pack up your house beverages to-go with TableCraft's Plastic Beverage Pouches. They're a fun alternative to plastic, styrofoam, or a paper cup! Available in varying capacities to fill with your drink specials, juices, mixers, fruits or veggies and more! Perfect for carry out and to-go beverages for your customers to enjoy from the comforts of their own homes. Pouches also work well to store and seal food and ingredients to prepare take away meal kits. Translucent polyethylene pouch design opens so you can stand it up; making filling and prepping simple and easy.

- Cash & Carry packs available for 10 and 16 ounce capacity pouches
- Single Use Recyclable Plastic



View our video on the To-Go Pouches

get going

AVAILABLE FOR CASH & CARRY



Item #	Description	Count Per Pack	Min Order
TO-GO POUCHES, TRANSLUCENT POLYETHYLENE			
a. 10681	10 oz Pouch	100	1 pk
b. 10682	16 oz Pouch	100	1 pk
10683	32 oz Pouch	100	1 pk
CASH & CARRY TO-GO POUCHES, TRANSLUCENT POLYETHYLENE			
c. 10883*	10 oz Pouch	50	1 pk
d. 10884*	16 oz Pouch	50	1 pk

Works with our paper straws, see table below to check out coordinating straws that you can pack up with the To-Go Pouch!

Pouch:	Fits Straw(s):
10 oz	6mm Straws (7 $\frac{3}{4}$ " & 10")
16 oz	6mm Straws (7 $\frac{3}{4}$ " & 10")
32 oz	6mm Straws (7 $\frac{3}{4}$ " & 10")

Great for stocking grab & go, buffet lines, or self-service stations



Custom imprinting available, contact your TableCraft representative for further information.



WORRY-FREE COCKTAIL SERVICE



Each holds a standard 750 ml bottle and will make a stylish addition to the bar or tabletop service

WINE FLIGHTS

- An appealing and convenient way to serve wine tastings
- Holds up to (3) 5" dia wine glasses (Not Included)

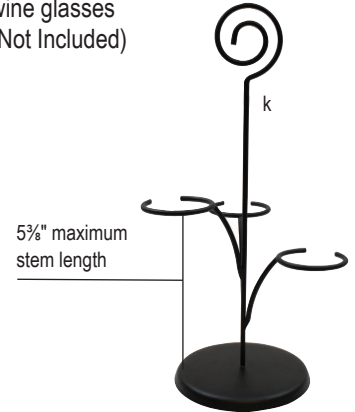

Also a convenient option to serve your condiments and sides



Fits the following ramekin options:
5063, 5066, 5068, 5071, 5072, 10768, 10789, 240002, 240010 & GRS83



ASSORTED WINE COOLERS & STAINLESS STEEL ICE BUCKETS

Double wall Stainless Steel construction to reduce condensation while serving chilled wine, champagne or ice



BPA FREE

BPA-Free, water clear plastic construction

Great for poolside, indoor and outdoor beverage service or room service



Item #	Description	Capacity	Min Order
ICE BUCKETS, WINE SERVERS & COOLERS—STAINLESS STEEL, MARBLE OR SANS PLASTIC			
a.	RIB76 Double Wall Ice Bucket, Stainless Steel, 6" dia x 6½" H	58 oz	1 ea
b.	10700 Double Wall Ice Bucket, Stainless Steel, 6" dia. x 6½"	55 oz	1 ea
c.	10701 Double Wall Wine Cooler, Stainless Steel, 4¾" dia. x 7¼" H	Holds 4¼" dia bottle	1 ea
d.	*H303 Double Wall Ice Bucket, Stainless Steel, Includes Tongs, 7¾" dia x 8¾"	120 oz	1 ea
e.	10011 Double Wall Wine Cooler, Stainless Steel Mirror Finish, 4¾" dia x 7½" H (replaces item 37)	Holds 3¾" dia bottle	1 ea
f.	*5488 Marble Wine Cooler, Black, 5" dia x 7" H	Holds 4" dia bottle	1 ea
g.	*5488W Marble Wine Cooler, White, 5" dia x 7" H	Holds 4" dia bottle	1 ea
h.	PB5119 SAN Plastic Wine Cooler, Clear, 8½ x 7¼ x 9"	2¾ qt	1 ea
i.	PB5115 SAN Plastic Wine Bucket with Handles, Clear 7 x 6½ x 6"	1½ qt	1 ea
j.	PB5120 SAN Plastic Wine Bucket with Handles, Clear 8½ x 8½ x 8½"	3½ qt	1 ea
WINE FLIGHTS— BLACK POWDER COATED STEEL			
k.	WF200BK Black Powder Coated, 7½" dia x 14¼"	—	1 ea

*Available as Cash & Carry

BARTENDING TOOLS



Color-coded caps for storage and prep. Our caps fit snug and stay secure; even in fast-paced, harsh speed rail and bar environments



View our video on all the benefits of the PourMaster® Series

Integrated spout is easier to clean than traditional two-piece neck/spouts

Oval neck with textured step design provides better ergonomics—making gripping, holding, lifting, and pouring safer and easier than the competitors' smooth round design

Features ridges on the base of the neck to give positive grip when tightening or loosening the neck



POURMASTER® ONE-PIECE NECK/SPOUT

- Integrated spout is easier to clean than traditional two-piece neck/spouts and no spout to lose, break or get clogged
- Color-coded for easy identification and quick selection at busy times
- Oval neck with textured step design provides better ergonomics
- Easy-pour bottles with clog-resistant spouts for mixers and juices
- Thicker thread, improved design with greater overlap for superior hold and leak protection
- Assorted packs include 2 of each color
- Necks are cross-compatible—our necks are interchangeable with most competitors' jars



Item #	Description	Capacity	Min Order
POURMASTER® ONE-PIECE NECK / SPOUT COMPLETES-POLYETHYLENE			
a. 10285A	Complete, Assorted Colors	1 qt	12 ea
REPLACEMENT PARTS			
10286BR	Brown Neck/Spout Only, fits 1032J, 1064J, and 1128J	–	1 ea
10286GN	Green Neck/Spout Only, fits 1032J, 1064J, and 1128J	–	1 ea
10286R	Red Neck/Spout Only, fits 1032J, 1064J, and 1128J	–	1 ea
10286W	White Neck/Spout Only, fits 1032J, 1064J, and 1128J	–	1 ea
10286X	Orange Neck/Spout Only, fits 1032J, 1064J, and 1128J	–	1 ea
10286Y	Yellow Neck/Spout Only, fits 1032J, 1064J, and 1128J	–	1 ea

Additional replacement parts available, see table on page 205.

Thicker thread with improved design and greater overlap for superior hold and leak protection



Integrated vent for fast, smooth pours

POURMASTER® SERIES

- Easy-pour bottles with clog-resistant spouts for mixers and juices
- Color-coded for easy identification and quick selection at busy times
- Assorted packs include 2 of each color



Item #	Description	Capacity	Min Order
POURMASTER®-LDPE BOTTLE, HDPE TOP & CAP			
b. N32A	Long Neck Top™, Assorted Colors	1 qt	12 ea
c. N32VA	V-Neck Top™, Assorted Colors	1 qt	12 ea
d. N32LPA	Low Profile Top™, Assorted Colors	1 qt	12 ea

See next page for replacement parts

Assorted colors include: green, white, orange, red, yellow and brown



it's all about the **spout**

COMPLETES

- Complete set includes: container, easy grip neck with snap-tight color pourer and a color-coded cap for easy storage
- "Assorted" includes 2 of each color for N32A, N32VA, N32LPA and 8032A
- "Assorted" includes 1 of each color for 8064A and 8128A



Assorted colors include: green, white, orange, red, yellow and brown



BACKUPS

- Includes container and color-coded cap
- "Assorted" includes 2 of each color for JC1032A
- "Assorted" includes 1 of each color for JC1064A and JC1128A



d / e / f



b / c



g: Green, Red, White, Orange, or Yellow



Item #	Description	Capacity	Min Order
COMPLETES—POLYETHYLENE, SAN SPOUT			
a. 8032A	Complete, Assorted Colored Spouts	1 qt	12 ea
b. 8032BKBK	Complete, Black Bottle & Cap, Clear Spout	1 qt	12 ea
8032BR	Complete, Natural Bottle, Brown Cap & Spout	1 qt	12 ea
8032GN	Complete, Natural Bottle, Green Cap & Spout	1 qt	12 ea
8032R	Complete, Natural Bottle, Red Cap & Spout	1 qt	12 ea
8032W	Complete, Natural Bottle, White Cap, Clear Spout	1 qt	12 ea
8032X	Complete, Natural Bottle, Orange Cap & Spout	1 qt	12 ea
8032Y	Complete, Natural Bottle, Yellow Cap & Spout	1 qt	12 ea
c. 8064A	Complete, Natural Bottle, Orange Spout	1 gal	6 ea
8064X	Complete, Natural Bottle, Orange Cap & Spout	½ gal	6 ea
8128A	Complete, Assorted Colored Spouts	1 gal	6 ea
BACKUPS—HIGH DENSITY POLYETHYLENE			
JC1032_	Quart, 3½" dia x 6¾", (Brown, Green, Red, White, Orange, or Yellow)	1 qt	12 ea
d. JC1032A	QUART (ASSORTED COLORS), 3½" dia x 6¾"	1 qt	12 ea
JC1064_	Half Gallon, 4½" dia x 8¾", (Brown, Green, Red, White, Orange, or Yellow)	½ gal	6 ea
e. JC1064A	HALF GALLON (ASSORTED COLORS), 4½" dia x 8¾"	½ gal	6 ea
JC1128_	Gallon, 6" dia x 10", (Brown, Green, Red, White, Orange, or Yellow)	1 gal	6 ea
f. JC1128A	Gallon (Assorted Colors), 6" dia x 10"	1 gal	6 ea

Item #	Description	Min Order
REPLACEMENT PARTS & ACCESSORIES		
1014	Neck for Pourmaster®, Quart	1 ea
1013A	Spouts for PourMaster® Completes, Assorted	1 ea
1013_	Spout Only (Brown, Green, Red, White, Orange, or Yellow)	1 ea
1014BK	Neck for Pourmaster®, Black	1 ea
1017A	Caps for Pourmaster® Completes, Assorted	1 ea
1017_	Cap only for Pourmaster®, (Black, Brown, Green, Red, White, Orange, or Yellow)	1 ea
1032J	Jar only for Pourmaster® 32 oz	1 ea
1032JBK	Jar only for Pourmaster®, Black, 32 oz	1 ea
1064J	Jar Only for JC1064A, ½ Gal	1 ea
1128J	Jar Only for JC1128A, 1 Gal	1 ea
N16R	Low Profile Top for N32LPA, N32LPR (Red)	1 ea
N32LP_	1 Qt Pourmaster®, Low Profile Top (Red, Orange, or Yellow)	1 ea
g. N32_	1 Qt Pourmaster®, Long Neck Top (Green, Red, White, Orange, or Yellow)	1 ea
N32J	1 Qt NSF Pourmaster® Jar	1 ea
N14_	Pourmaster Neck for N32A (Brown, Green, Red, White, Orange, or Yellow)	1 ea
N14V_	V-Neck Top for N32VA (Brown, Green, Red, White, Orange, or Yellow)	1 ea
N16_	Low Profile Top for N32LPA (Brown, Green, Red, White, Orange, or Yellow)	1 ea
N16_FLP	Low Profile Flip Hinge for Pourmaster® Low Profile Top (Brown, Green, Red, White, Orange, or Yellow)	1 ea
N17_	Pourmaster™ Storage Top (Brown, Green, Red, White, Orange, or Yellow)	1 ea

TO ORDER:

N14 **Y**

ITEM NUMBER COLOR CODE

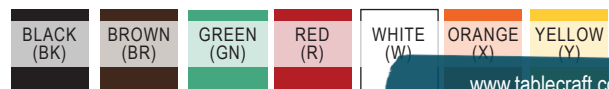



Providing Solutions for over 75 Years
Every Ware. Every Day.

WORLD HEADQUARTERS

801 Lakeside Drive
Gurnee, Illinois 60031
847.855.9000
847.855.9012 fax